

PATIENT INFORMATION

VITRAKVI (vi trak vee)
(larotrectinib)
capsules and oral solution

What is VITRAKVI?

VITRAKVI is a prescription medicine that is used to treat adults and children with solid tumors (cancer) that:

- are caused by certain abnormal NTRK genes **and**
- have spread or if surgery to remove their cancer is likely to cause severe complications, **and**
- there is no acceptable treatment option **or** the cancer grew or spread on other treatment.

Your healthcare provider will perform a test to make sure that VITRAKVI is right for you.

It is not known if VITRAKVI is safe and effective in children younger than 1 month of age.

Before taking VITRAKVI, tell your healthcare provider about all of your medical conditions, including if you:

- have liver problems
- have nervous system (neurological) problems
- are pregnant or plan to become pregnant. VITRAKVI can harm your unborn baby. You should not become pregnant during treatment with VITRAKVI.
 - If you are able to become pregnant, your healthcare provider may do a pregnancy test before you start treatment with VITRAKVI.
 - **Females who are able to become pregnant** should use effective birth control (contraception) during treatment and for at least **1 week** after the final dose of VITRAKVI. Talk to your healthcare provider about birth control methods that may be right for you.
 - **Males with female partners who are able to become pregnant** should use effective birth control during treatment with VITRAKVI and for at least **1 week** after the final dose of VITRAKVI.
- are breastfeeding or plan to breastfeed. It is not known if VITRAKVI passes into your breast milk. Do not breastfeed during treatment and for 1 week after the last dose of VITRAKVI.

Tell your healthcare provider about all the medicines you take, including prescription and over-the-counter medicines, vitamins, and herbal supplements. Certain other medicines may affect how VITRAKVI works. Know the medicines you take. Keep a list of them to show your healthcare provider and pharmacist when you get a new medicine.

How should I take VITRAKVI?

- Take VITRAKVI exactly as your healthcare provider tells you.
- Your healthcare provider may stop treatment or change your dose of VITRAKVI if you have side effects. Do not change your dose or stop taking VITRAKVI unless your healthcare provider tells you.
- VITRAKVI comes in capsules and as an oral solution.
- If your healthcare provider prescribes VITRAKVI oral solution:
 - Your healthcare provider will provide you with the VITRAKVI oral solution and oral syringes or send you to a pharmacy that can provide you with VITRAKVI oral solution and oral syringes.
 - Your healthcare provider should show you how to correctly measure and give a dose of VITRAKVI oral solution.
 - See the detailed Instructions for Use that comes with VITRAKVI oral solution for information about the correct way to measure and give a dose of VITRAKVI oral solution. If you have any questions, talk to your healthcare provider or pharmacist.
- VITRAKVI is usually taken by mouth 2 times a day.
- Swallow VITRAKVI capsules whole. Do not chew or crush the capsules.
- Take VITRAKVI with or without food.
- If you vomit after taking a dose of VITRAKVI, wait and take the next dose at your scheduled time
- If you miss a dose of VITRAKVI, take it as soon as you remember unless your next scheduled dose is due within 6 hours. Take the next dose at your regular time.

If you take too much VITRAKVI, call your healthcare provider.

What should I avoid while taking VITRAKVI?

- VITRAKVI can make you feel dizzy. Do not drive or operate machinery until you know how VITRAKVI affects you.
- Avoid taking St. John's wort, eating grapefruit, or drinking grapefruit juice during treatment with VITRAKVI.

What are the possible side effects of VITRAKVI?

VITRAKVI may cause serious side effects, including:

- **Nervous system problems.** Tell your healthcare provider if you develop any symptoms such as confusion, difficulty speaking, dizziness, coordination problems, tingling, numbness, or burning sensation in your hands and feet. Your healthcare provider may temporarily stop treatment, decrease your dose, or permanently stop VITRAKVI if you develop symptoms of a nervous system problem with VITRAKVI.

- **Liver problems.** Your healthcare provider will do blood tests to check your liver function during treatment with VITRAKVI. Tell your healthcare provider right away if you develop symptoms of liver problems including: loss of appetite, nausea or vomiting, or pain on the upper right side of your stomach area. Your healthcare provider may temporarily stop treatment, decrease your dose, or permanently stop VITRAKVI if you develop liver problems with VITRAKVI.

The most common side effects of VITRAKVI include:

- tiredness
- nausea
- dizziness
- vomiting
- cough
- constipation
- diarrhea

VITRAKVI may affect fertility in females and may affect your ability to become pregnant. Talk to your healthcare provider if this is a concern for you.

These are not all the possible side effects with VITRAKVI. Call your healthcare provider for medical advice about side effects. You may report side effects to FDA at 1-800-FDA-1088.

How should I store VITRAKVI?

- Store VITRAKVI capsules at room temperature between 68°F to 77°F (20°C to 25°C).
- Store VITRAKVI oral solution in the refrigerator between 36° F to 46° F (2° C to 8° C). Do not freeze.
- Throw away (dispose of) any unused VITRAKVI oral solution remaining after 90 days of first opening the bottle.

Keep VITRAKVI and all medicines out of the reach of children.

General information about the safe and effective use of VITRAKVI.

Medicines are sometimes prescribed for purposes other than those listed in a Patient Information leaflet. Do not use VITRAKVI for a condition for which it was not prescribed. Do not give VITRAKVI to other people, even if they have the same symptoms you have. It may harm them. You can ask your healthcare provider or pharmacist for more information about VITRAKVI that is written for health professionals.

What are the ingredients in VITRAKVI?

Active ingredient: larotrectinib

Inactive ingredients:

Capsule: gelatin, titanium dioxide and edible ink

Oral Solution: purified water, hydroxypropyl betadex, sucrose, glycerin, sorbitol, citric acid, sodium phosphate, sodium citrate dihydrate, propylene glycol and flavoring. Preserved with methylparaben and potassium sorbate.

Manufactured for Bayer HealthCare Pharmaceuticals Inc., Whippany, NJ 07981
For more information, go to www.VITRAKVI.com or call 1-888-842-2937

This Patient Information has been approved by the U.S. Food and Drug Administration.

Revised: 7/2019

INSTRUCTIONS FOR USE
VITRAKVI (vi trak vee)
(larotrectinib)
oral solution

Read this Instructions for Use before you take or give a dose of VITRAKVI oral solution for the first time and each time you get a refill. There may be new information. This information does not take the place of talking with your healthcare provider about your medical condition or your treatment.

Your healthcare provider should show you how to correctly measure the prescribed dose of VITRAKVI oral solution before you take or give a dose for the first time.

Important information about measuring VITRAKVI oral solution:

- Always use the oral syringes provided with VITRAKVI to make sure that you correctly measure the prescribed dose.
- When you receive VITRAKVI oral solution from your healthcare provider or pharmacist, you will get a box that contains 1 glass bottle of VITRAKVI oral solution and a bottle adaptor. You may receive more than 1 box of VITRAKVI oral solution.
- You will receive five 1 mL or 5 mL oral syringes that are marked to help you correctly measure the prescribed dose of VITRAKVI oral solution. Each oral syringe may be used over a 7-day period. **Do not** use a household teaspoon to measure the dose.

Supplies needed to take or give a dose of VITRAKVI oral solution

Figure A

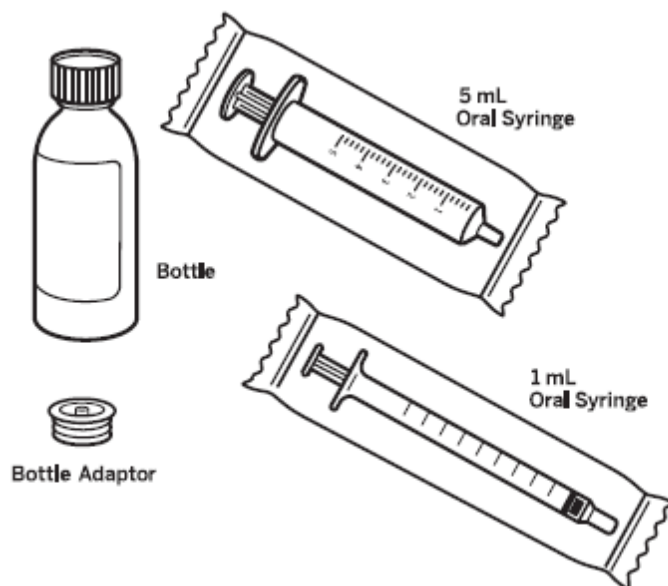

How to prepare a dose of VITRAKVI oral solution:

Step 1: Remove the VITRAKVI oral solution bottle from the box. Place the bottle on a flat work surface. Open the bottle by pushing down firmly on the child-resistant cap and turning it in the direction of the arrow (counter-clockwise) **See Figure B.** **Do not** throw away the child-resistant cap.

Figure B



Step 2: Insert the bottle adaptor by pressing it into the bottle neck and make sure it is secure. **See Figure C.** **Do not** remove the bottle adaptor. If the bottle adaptor is missing, talk to your healthcare provider.

Figure C



Step 3: Remove the oral syringe from the wrapper. Throw the wrapper away in your household trash. The barrel of the oral syringe has markings in milliliters (mL). Look at the markings on the barrel of the oral syringe and find the mL marking that matches the VITRAKVI oral solution dose in mL prescribed by your healthcare provider. **See Figure D.**

Figure D

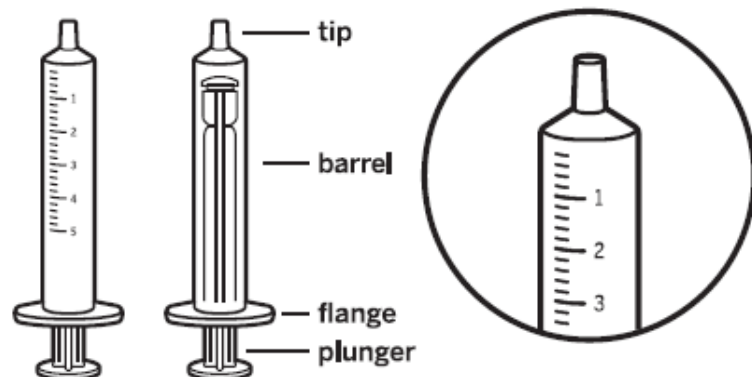

Step 4: With the bottle on your flat work surface, use 1 hand to hold the bottle upright. Using your other hand, push the air out of the oral syringe by pushing the plunger down. Then, insert the tip of the oral syringe into the bottle adaptor at the top of the bottle. **See Figure E.** The tip of the oral syringe should fit snugly into the hole of the bottle adaptor.

Figure E

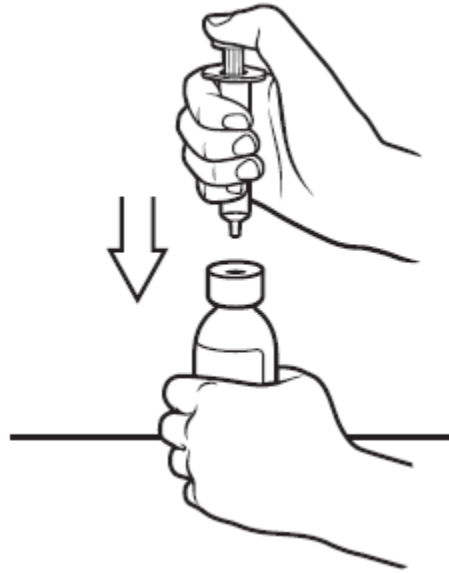

Step 5: Use 1 hand to hold the oral syringe in place. With the other hand, turn the bottle upside down. Pull back on the plunger until the top of the plunger lines up with the marking on the barrel of the oral syringe that matches the dose of VITRAKVI oral solution prescribed by your healthcare provider. **See Figure “F”**. Your dose may be different than the dose shown in Figure F.

Figure F

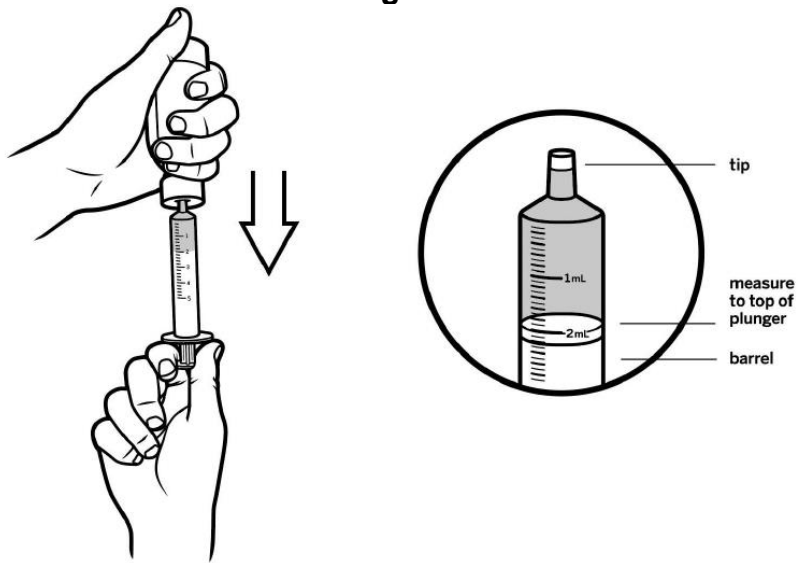

Step 6: Check for air bubbles in the oral syringe. If you see air bubbles, push up gently on the plunger to push any large air bubbles back into the bottle. Then, pull back on the plunger to the prescribed dose. **See Figure G.**

Figure G

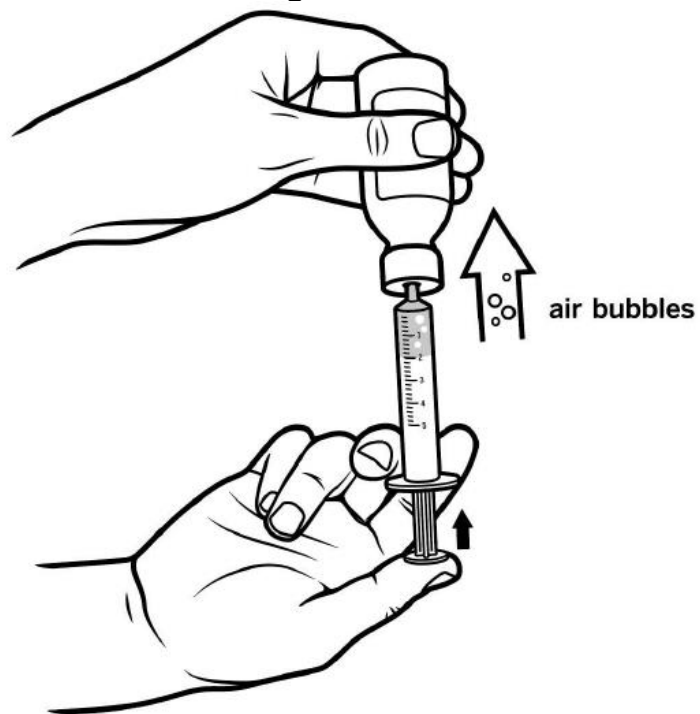

Step 7: Turn the bottle upright again and place it on your work surface. Remove the oral syringe from the bottle adaptor by gently pulling up on the syringe barrel.

See Figure H. Do not push on the plunger during this step. The bottle adaptor should stay attached to the bottle.

Figure H

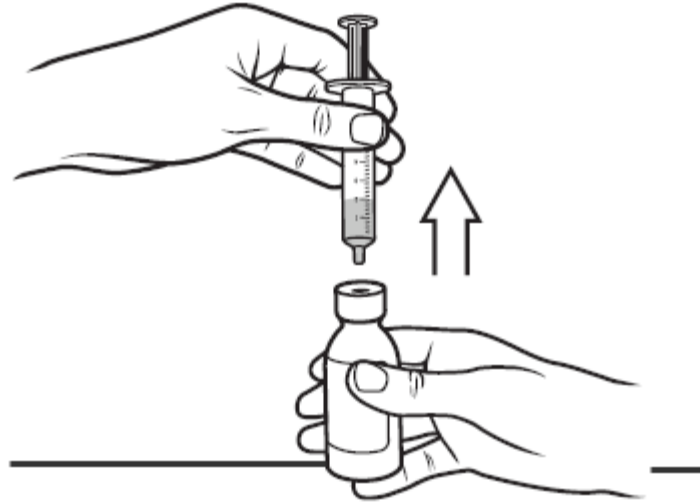

Giving a dose of VITRAKVI oral solution by mouth:

Step 8: Place the tip of the oral syringe into the child's mouth against the inside of the cheek. Slowly squirt VITRAKVI oral solution into the mouth by pressing down on the plunger and allow the child to swallow. **See Figure I.**

- The child should be kept in an upright position for a few minutes right after giving a dose of VITRAKVI.
- If the child spits up a dose or you are not sure the entire dose was given, do not give another dose. Wait until the next scheduled dose.

Figure I

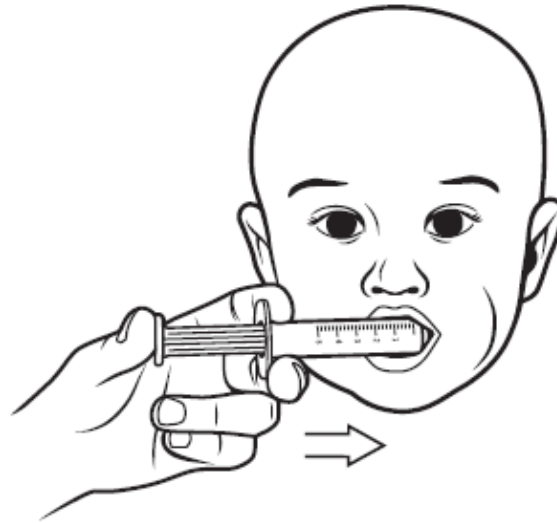

Step 9: Replace the child-resistant cap on the bottle of VITRAKVI oral solution. **Do not** remove the bottle adaptor. Close the bottle by turning the bottle cap in the direction of the arrow (clockwise). **See Figure J.**

Figure J

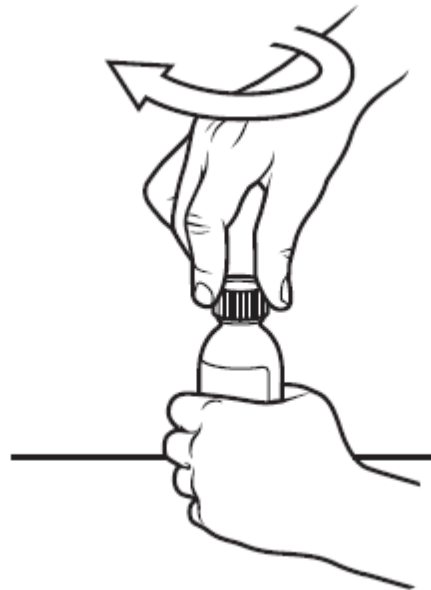

Cleaning instructions for oral syringes

Follow the instructions below for cleaning the oral syringe (Step 10 through Step 16). After 7 days of use, throw away the oral syringe in your household trash. Use a new one for the next 7 days.

Step 10: Remove plunger from the barrel of the oral syringe. **See Figure K.**

Figure K

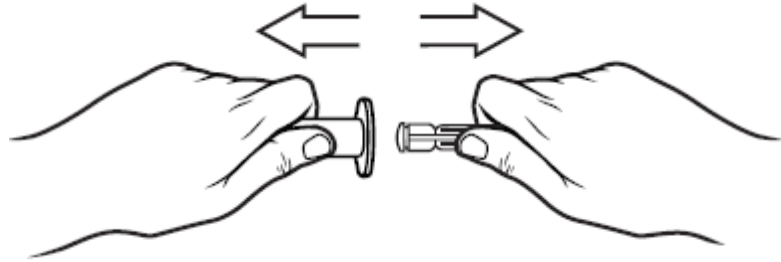

Step 11: Rinse the barrel and plunger in warm running water to help ensure that all of the medicine has been removed from the oral syringe. **See Figure L.** **Do not** boil the oral syringe.

Figure L

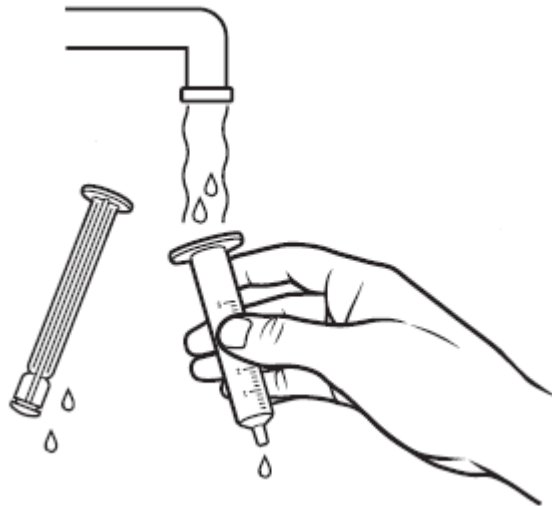

Step 12: Re-insert the plunger into the barrel of the oral syringe. **See Figure M.**

Figure M

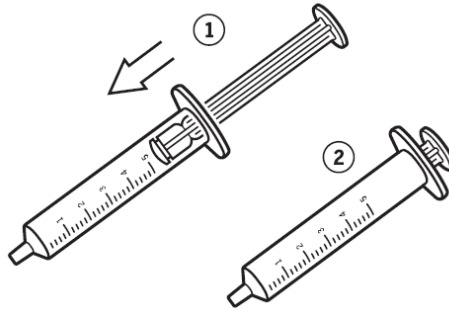

Step 13: Draw warm water several times into the oral syringe and squirt out again until all of the medicine has been removed from the oral syringe. **See Figure N.**

Figure N

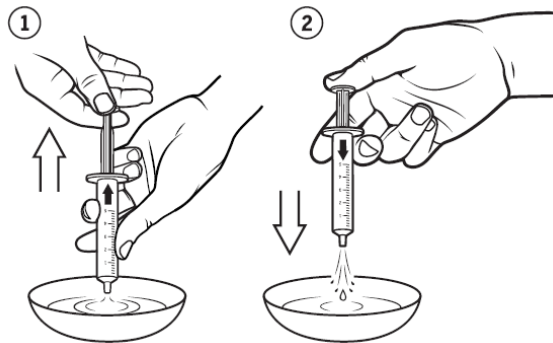

Step 14: Disassemble the oral syringe, and rinse the barrel and plunger again with warm water. **See Figure O.**

Figure O

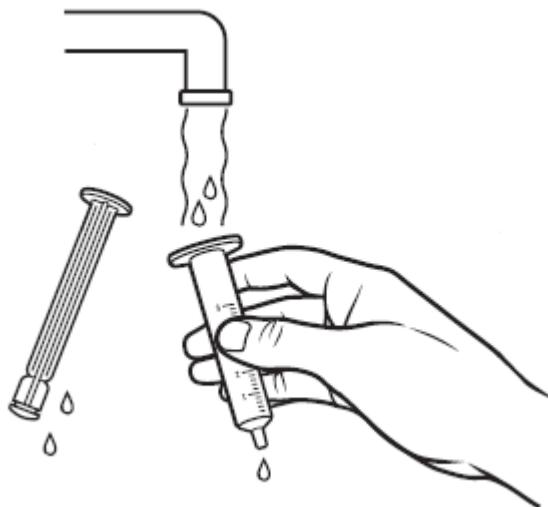

Step 15: Shake off excess water or wipe off the outside, and then place the barrel and plunger on a clean, dry paper towel to dry. **See Figure P.**

Figure P

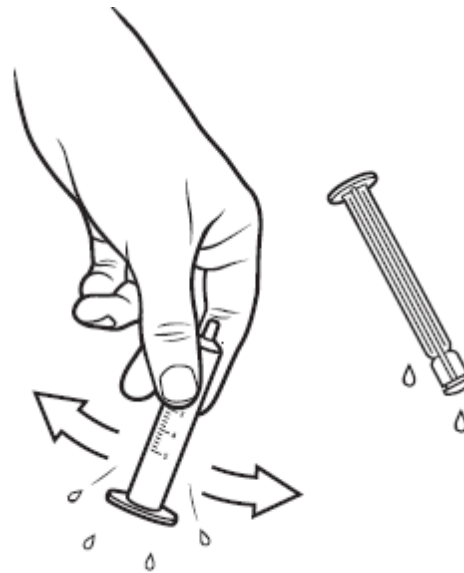

Step 16: Assemble the oral syringe and store in a clean place until the next use.

Replace the oral syringe after 7 days of use, **or** if:

- there is any damage to the barrel, plunger, or tip
- the dosage marking is no longer clearly recognizable or
- it becomes difficult to move the plunger

How should I store VITRAKVI oral solution?

- Store VITRAKVI oral solution in a refrigerator between 36° F to 46° F (2° C to 8° C). **Do not** freeze.
- Throw away any unused medicine 90 days after the date of first opening. Write the date that you opened the bottle of VITRAKVI oral solution on the bottle. **See Figure Q.**

Keep VITRAKVI oral solution and all medicines out of the reach of children.

Figure Q



Talk to your healthcare provider if you have questions about how to use VITRAKVI oral solution.

For more information, go to www.VITRAKVI.com or call 1-888-842-2937.

This Instructions for Use has been approved by the U.S. Food and Drug Administration.

Manufactured for Bayer HealthCare Pharmaceuticals Inc., Whippany, NJ 07981

Revised: July 2019